

Article number: 2310306961

Description: E+G Levelling element
LV.A-125-APS-M20x95

Measures

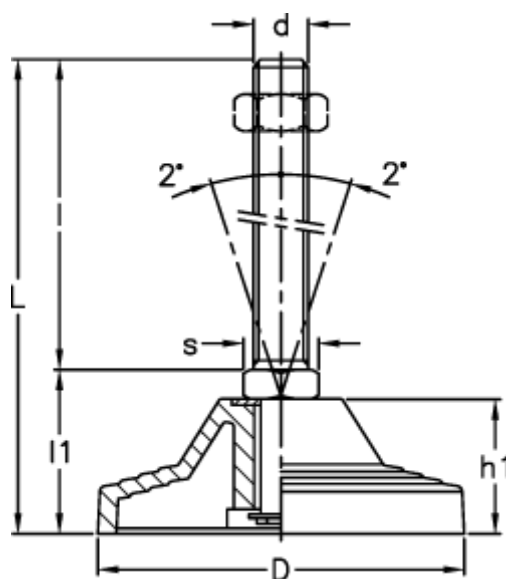

d	= M20
D	= 125
h	= 45
l	= 95
L	= 150
l1	= 55
Max load (N)	= 40000
s	= 24